

MX Series Power Systems

Programmable AC and DC Power Source / Analyzer



- **High Power AC and DC Power Source**
Programmable AC and DC power for frequency conversion and product test applications.
- **Expandable Power Levels**
Available output power of 30 and 45 KVA per unit and multi-unit configurations for power requirements up 135 KVA.
- **Single and Three phase mode**
Phase mode programming on MX30-3Pi and MX45-3Pi allows switching between single and three phase output modes.
- **Arbitrary Waveform Generation**
User defined voltage waveform and distortion programming.
- **Multiple Voltage Ranges**
Available 150, 300 or 400 Volt ranges in AC mode and 200 or 400 Volt ranges in DC mode.
- **High RMS Current and Peak Current**
Maximum current of 200 A RMS (MX30) and 300 A RMS (MX45) per chassis and 3:1 Crest factor capability.
- **Remote Control**
IEEE-488 and RS232C Interfaces for automated test applications.

Introduction

The MX Series consists of a number of high power AC and DC power systems that provide controlled AC and DC output for ATE and product test applications.

Available in power levels from 30 kVA and 45 kVA to 135 kVA, this high power AC and DC test system covers a wide spectrum of AC and DC power applications at an affordable cost. Using state-of-the-art PWM switching techniques, the MX series combines compactness, robustness and functionality in a compact floor-standing chassis, no larger than a typical office copying machine. This higher power density has been accomplished without the need to resort to elaborate cooling schemes or special installation wiring. Roll the MX30 or MX45 unit to its designated location - casters included - and plug it in.

Simple Operation

The MX Series can be operated completely from its menu driven front panel controller. A large backlit LCD display shows menus, setup data and read-back measurements and is angled to provide easy viewing. IEEE-488 and RS232C remote control interfaces and instrument drivers for popular ATE programming environments are available as well. This allows the MX Series to be easily integrated into an automated test system.

For advanced test applications, the programmable controller version offers full arbitrary waveform generation, time and frequency domain measurements and voltage and current waveform capture.

Configurations

The MX30 delivers up to 30 kVA, the MX45 up to 45 kVA of single or three phase output in AC mode. In DC mode, 65 % of the AC power level is available. On MX models with the programmable controller, an AC+DC mode is also supported.

For higher power requirements, MX90 and MX135 models are available. Multi cabinet MX45 systems always operate in three phase output mode. Available reconfigurable MX90 and MX135 models (-MB designation) provide multiple controllers which allow separation of the high power system into two or three individual MX45 units for use in separate applications. This ability to reconfigure the system provides a great level of flexibility.

MX Series - Multi-Function and Multi-Use

Product Evaluation and Test

Increasingly, manufacturers of high power equipment and appliances are required to fully evaluate and test their products over a wide range of input line conditions. The built-in output transient generation and read-back measurement capability of the MX Series offers the convenience of an easy to use and integrated test system.

Avionics

With an output frequency range to 819 Hz, the MX Series is well suited for aerospace applications. Precise frequency control and accurate load regulation are key requirements in these applications. The available IEEE-488 control interface and SCPI command language provide for easy integration into existing ATE systems. The MX Series can eliminate the need for several additional pieces of test equipment, saving cost and space. Instrument drivers for popular programming environments such as National Instruments LabView™ are available to speed up system integration.

Regulatory Testing

As governments are moving to enforce product quality standards, regulatory compliance testing is becoming a requirement for a growing number of manufacturers. The MX Series is designed to meet AC source requirements for use in Euronorm EN61000-3-11 flicker compliance testing.

Choice of voltage ranges

The MX30 and MX45 can be ordered with either a 150 V RMS Line to Neutral output voltage range or a 300 V RMS Line to Neutral range. This provides 3 phase output capability of 260 Vac or 520 Vac line to line respectively. If dual output ranges are required, the programmable range change option (-R) provides the ability to switch between both output ranges. Pi version models offer standard dual voltage ranges.

The DC output mode changes the 150 V AC range to a 200 V DC output range; the 300 V AC range becomes 400 V DC.

For applications requiring more than 300 V L-N (or 520 V L-L), the -HV1 output transformer option provides an additional 400 V L-N and 693 V L-L output range for use in AC mode only.

Multi-Box Configurations

For high power applications, two or three MX45 chassis can be combined to provide 90 to 135 kVA of three phase power. MX90 and MX135 systems are always configured for three phase operation.

High Crest Factor

With a crest factor of up to 3:1, the MX Series AC source can drive difficult nonlinear loads with ease. Since many modern products use switching power

supplies, they have a tendency to pull high repetitive peak currents. The MX30-3Pi can deliver up to 200 Amps of repetitive peak current (150 V AC range) per phase to handle three phase loads, and the MX45-3Pi can deliver up to 300 Amps. 600 Amps (MX30) and 900 Amps (MX45) is available in single phase mode.

Remote Control

IEEE-488 and RS232C remote control interfaces allow programming of all instrument functions from an external computer. The popular SCPI command protocol is used for programming.

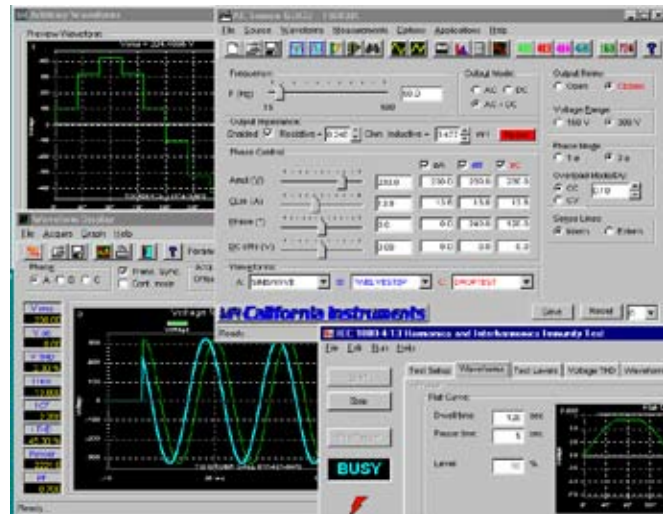

Application Software

Windows® application software¹ is provided free of charge with the programmable controller version [Pi] or the standard controller with the "-P" option. This software provides easy access to the power source's capabilities without the need to develop any custom code. The following functions are available through this GUI program:

- Steady state output control (all parameters)
- Create, run, save, reload and print transient programs
- Generate and save harmonic waveforms. [Pi only]
- Generate and save arbitrary waveforms. [Pi only]
- Measure and log standard measurements
- Capture and display output voltage and current waveforms. [Pi only]
- Measure, display, print and log harmonic voltage and current measurements. [Pi only]
- Display IEEE-488 or RS232C bus traffic to and from the AC Source to help you develop your own test programs.

¹ Requires PC running Windows Win98™ or Win 2000™. Recommended Pentium 400 MHz or better.

MX Series - Waveform Generation [Pi controller]

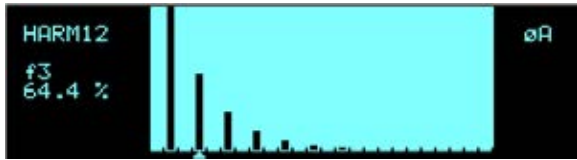

Harmonic waveform, Fund., 3rd, 5th, 7th, 9th, 11th and



Two hundred user defined waveforms.

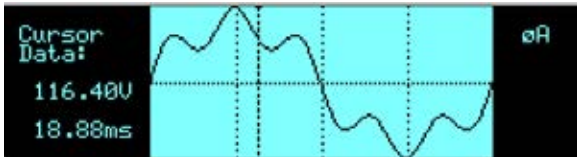

Harmonically distorted waveform.

Harmonic Waveform Generation

Using the latest DSP technology, the MX Series programmable controller is capable of generating harmonic waveforms to test for harmonics susceptibility. The Windows Graphical User Interface program can be used to define harmonic waveforms by specifying amplitude and phase for up to 50 harmonics. The waveform data points are generated and downloaded by the GUI to the AC source through the IEEE-488 or RS232C bus. Up to 200 waveforms can be stored in nonvolatile memory and given a user defined name for easy recall.

All MX-Pi Series configurations offer three phase waveform generation, allowing independent phase anomalies to be programmed. It also allows simulation of unbalanced harmonic line conditions.

Arbitrary Waveform Generation

Using the provided GUI program or custom software, the user also has the ability to define arbitrary AC waveforms. The arbitrary waveform method of data entry provides an alternative method of specifying AC anomalies by providing specific waveform data points. The GUI program provides a catalog of custom waveforms and also allows real-world waveforms captured on a digital oscilloscope to be downloaded to one of the many AC source's waveform memories. Arbitrary waveform capability is a flexible way of simulating the effect of real-world AC power line conditions on a unit under test in both engineering and production environments.

MX Series - AC and DC Transient Generation

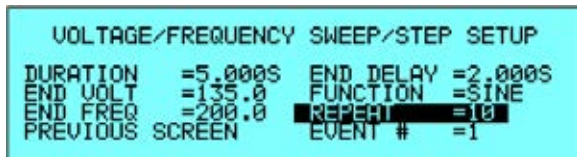

Transient List Data Entry from the front panel.

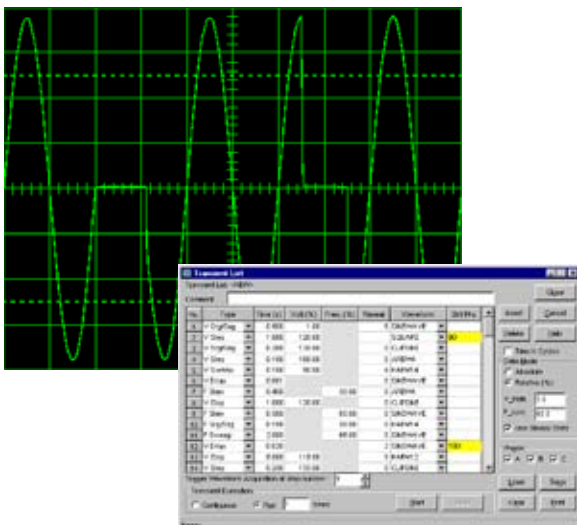

Transient List Data Entry in GUI program.

The MX Series controller has a powerful AC and DC transient generation system that allows complex sequences of voltage, frequency and waveshapes to be generated. This further enhances the MX's capability to simulate AC line conditions or DC disturbances. When combined with the multiphase arbitrary waveform capabilities, the AC and DC output possibilities are truly exceptional. Transient generation is controlled independently yet time synchronized on all three phases. Accurate phase angle control and synchronized transient list execution provide unparalleled accuracy in positioning AC output events.

Transient programming is easily accomplished from the front panel where clearly laid out menu's guide the user through the transient definition process.

The front panel provides a convenient listing of the programmed transient sequence and allows for transient execution Start, Stop, Abort and Resume operations. User defined transient sequences can be saved to non-volatile memory for instant recall and execution at a later time. The included Graphical User Interface program supports transient definitions using a spreadsheet-like data entry grid. A library of frequently used transient programs can be created on disk using this GUI program.

MX Series - Measurement and Analysis

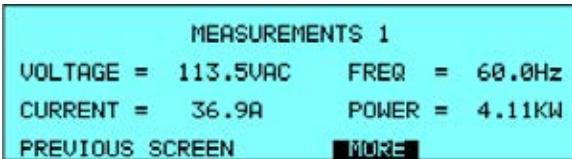

Measurement data for a single phase.

The MX Series is much more than a programmable AC, DC or AC+DC power source. It also incorporates an advanced digital signal processor based data acquisition system that continuously monitors all AC source and load parameters. This data acquisition system forms the basis for all measurement and analysis functions. These functions are accessible from the front panel and the remote control interface.

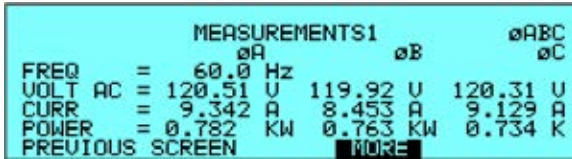

Measurement data for all three phases.

Conventional Measurements [All controllers]

Common AC and DC measurement parameters are automatically provided by the data acquisition system. These values are displayed in numeric form on the front panel LCD display. The following measurements are available: Frequency, V_{rms} , I_{rms} , I_{pk} , Crest Factor, Real Power (Watts), Apparent Power (VA) and Power Factor.

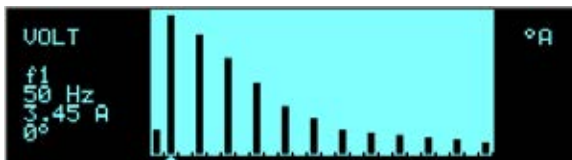

Absolute amplitude bar graph display of current harmonics with cursor positioned at the fundamental

Harmonic Analysis [Pi controller]

The MX Series provides detailed amplitude and phase information on up to 50 harmonics of the fundamental voltage and current (up to 6.7 kHz in three phase mode) for either one or three phases. Harmonic content can be displayed in both tabular and graphical formats on the front panel LCD for immediate feedback to the operator. Alternatively, the included GUI program can be used to display, print and save harmonic measurement data. Total harmonic distortion of both voltage and current is calculated from the harmonic data.

VOLT HARMONIC MEASUREMENTS @A					
HR#	AMPL.	PHASE	HR#	AMPL.	PHASE
0	0.00	0.0	1	151.42	0.0
2	0.33	46.9	3	116.17	351.4
4	0.57	90.1	5	85.24	29.6
6	0.59	131.8	7	54.72	67.0
8	0.45	171.4	9	24.55	100.6

Voltage harmonic measurement table display in absolute values

Waveform Acquisition [Pi controller]

The measurement system is based on real-time digitization of the voltage and current waveforms using a 4K deep sample buffer. This time domain information provides detailed information on both voltage and current waveshapes. Waveform acquisitions can be triggered at a specific phase angle or from a transient program to allow precise positioning of the captured waveform with respect to the AC source output.

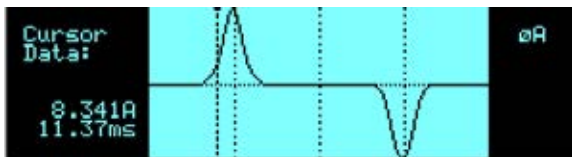

Acquired Current waveform

The front panel LCD displays captured waveforms with cursor readouts. The included GUI program also allows acquired waveform data to be displayed, printed and saved to disk.

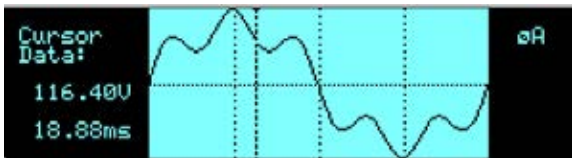

Acquired Voltage waveform

Acquired three phase voltage waveforms displayed on PC.

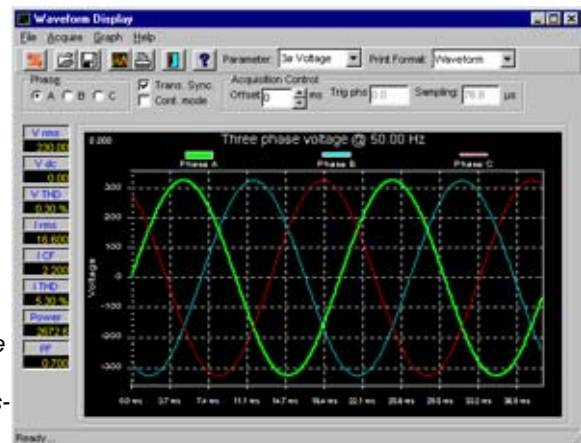

Specifications - applicable to MX30/45 Standard and Pi versions except where noted.

Operating Modes

Standard: AC and DC
Pi version: AC, DC and AC+DC

AC Mode Output

Frequency

Range: 16.00 - 819.0 Hz
-LF option: 16.00 - 500.0 Hz
(supplemental specifications apply above 500 Hz.)
Resolution: 0.01 Hz < 81.91 Hz
0.1 Hz > 82.0 Hz

Phase outputs

MX30/45-1: 1
MX30/45-3: 3 (A, B, C)
MX30-3Pi: 1 or 3 switchable.
MX45-3Pi: 1 or 3 switchable.
Neutral: Floating
Coupling: DC (except for -HV option)

Total Power

MX30-1/3: 30 kVA
MX45-1/3: 45 kVA
MX90: 90 kVA
MX135: 135 kVA

Load Power Factor

0 to unity at full output current.

AC Mode Voltage

Voltage Ranges [1 only on std]

Range:	V Low	V High
AC	0-150 V	0-300 V
AC+DC	0-150 V	0-300 V

Load Regulation

< 0.25 % FS DC to 100 Hz
< 0.5 % FS 100 Hz to 819 Hz

Line Regulation

< 0.1% FS or 10 % line change

External Sense

Voltage drop compensation

Output Noise (20 kHz to 1 MHz)

< 2 Vrms Low V range
< 3 Vrms High V range

Harmonic Distortion (Linear load)

Less than 1% from 16 - 66 Hz
Less than 2% above 66 Hz
Less than 3% above 500 Hz

DC Offset

< 20 mV

External Amplitude Modulation

Depth: 0 - 10 %
Frequency: DC - 2 KHz

Isolation Voltage

300 V_{RMS} output to chassis

AC Mode Current

Steady State AC Current @ FS V:

Model	V Low	V High
MX30-1	200	100
MX30-3	66.6/∅	33.3/∅
MX30-3Pi	66.6/∅	33.3/∅
1ph mode:	200	100
MX45-1	300	150
MX45-3	100/∅	50/∅
MX45-3Pi	100/∅	50/∅
1ph mode:	300	150
MX90-3/Pi	200/∅	100/∅
MX135-3/Pi	300/∅	150/∅

Note: Unique constant power mode provides increased current at reduced voltage. See chart next page.

Measurements - Standard

Parameter	Range	Accuracy* (±)	Resolution
AC Measurements			
Frequency	16 - 100 Hz	0.01% + 0.01 Hz	0.01 Hz
	100 - 820 Hz		
		< 100 Hz	100 - 500 Hz
RMS Voltage	0 - 400 V	0.05 V + 0.02%	0.1 V + 0.02%
RMS Current	0 - 160 A	0.15 A + 0.02%	0.3 A + 0.02%
Peak Current	0 - 400 A	0.15 A + 0.02%	0.3 A + 0.02%
Crest Factor	0.00 - 6.00	0.05	0.05
Real Power	0 - 15 kW	30 W + 0.1%	60 W + 0.1%
Apparent Power	0 - 15 kVA	30 VA + 0.1%	60 VA + 0.1%
Power Factor	0.00 - 1.00	0.01	0.02
Phase	0.0 - 360.0	2.0°	3.0°
DC Measurements			
DC Voltage	0 - 400 V	0.5 V	10 mV
DC Current	0 - 160 A	0.5 A	10 mA
Power	0 - 15 kW	0.15 kW	10 W

* Measurement system bandwidth = DC to 6.7 kHz. Accuracy specifications are valid above 100 counts. Current and Power Accuracy and Range specifications are times three for MX90, MX135 or MX30/45-3Pi in single phase mode. PF accuracy applies for PF > 0.5 and VA > 50 % of range.

Measurements - Harmonics [Pi controller only]

Parameter	Range	Accuracy* (±)	Resolution
Frequency	16.00-1000.0 Hz	0.03% + 0.03 Hz	0.01 Hz
	32.00 Hz - 6.7 kHz		
Phase	0.0 - 360.0°	2° typ.	0.5°
Voltage	Fundamental	750 mV	10 mV
	Harmonics 2 - 50	0.3% + 750 mV+0.3% /1 kHz	10 mV
Current	Fundamental	0.5 A	100 mA
	Harmonics 2 - 50	0.3% + 150 mA +0.3% /1 kHz	100 mA

* Accuracy specifications are valid above 100 counts. Accuracy specifications are for three phase mode. Harmonics frequency range for MX30/45-3Pi in single phase mode is 32 Hz - 19.5 kHz.

Note 1: Specifications are warranted over an ambient temperature range of 25±5° C. Unless otherwise noted, specifications are per phase for a sinewave with a resistive load and apply after a 30 minute warm-up period. For three phase configurations, all specifications are for L-N. Phase angle specifications are valid under balanced load conditions only.

Specifications - Continued

DC Mode Output

Maximum DC power at full scale of DC voltage range.

MX30-3Pi: 6.5 kW per output, 3 outputs. 20 kW in 1 channel mode.

MX45-3Pi: 10 kW per output, 3 outputs. 30 kW in 1 channel mode.

Voltage Ranges:

Range:	Low	High
	0 - 200 V	0 - 400 V

Output Accuracy:

± 1 Vdc

Load & Line Regulation:

see AC mode

Ripple:

< 2 Vrms Lo Range

< 3 Vrms Hi Range

Max. DC Current @ FS V per output:

Model	V Low	V High
MX30-1	100	50
MX30-3	33.3	16.6
MX30-3Pi	33.3	16.6
1 o/p mode:	100	50
MX45-1	150	75
MX45-3	50	25
MX45-3Pi	50	25
1 o/p mode:	150	75
MX90-3/Pi	100	50
MX135-3/Pi	150	75

Current Limit:

Programmable from 0 A to max. current for selected range.

AC+DC Mode Output [Pi]

Power:

Maximum current and power in AC+DC mode is same as DC mode.

General Specifications

Protection

Over Load:

Constant Current or Constant Voltage mode

Over Temperature:

Automatic shutdown

Storage

Non Volatile Memory storage:

8 instrument setups, 200 user defined waveforms [Pi only]

Waveforms

Waveform Types:

Std: Sine

Pi: Sine, Square, Clipped sine, User defined

User defined waveform storage [Pi version]:

Four groups of 50 user defined arbitrary waveforms of 1024 points for a total of 200. One group can be active at a time.

Transient Programming

Transient List Parameters:

Voltage, Frequency, Time or Cycles, Slow rate, Waveform shape, Repeat

Transient lists storage:

up to 32 transient steps per list

Time resolution / range:

1 ms / 1 ms - 90000 s

Maximum slew rate:

200 μ s for 10% to 90% of full scale change into resistive load

Waveform Acquisition [Pi]

Channels: Voltage and Current

Memory Depth: 4096 smpls/phs.

Maximum Sample Rate:

MX30-3Pi and MX45-3Pi: 13.02 ks/s in 3 phase mode, 39.0625 ks/s in 1 phase mode

All other models: 13.02 ks/s.

Triggering:

Auto, Phase, Transient.

Trigger Delay:

Pre-trigger 0 - 104 ms 1 σ
0 - 312 ms 3 σ

Post-trigger 0 - 1000 msec. (at max. sample rates)

Display:

Front panel Graphics Display with cursors.

Bus Interface:

Full bus access to waveform acquisition system.

Output Relay

Push button controlled or bus controlled output relay

Output impedance

Programmable Z available on MX30-3Pi and MX45-3Pi in 3 phase mode only. Specifications apply at 50 Hz fundamental.

Resistive: 1 - 200 mOhm

Inductive: 15 - 200 μ H

Remote Control

[Pi only or Std with -P option]

IEEE-488 Interface:

IEEE-488 (GPIB) talker listener.

Subset: AH1, C0, DC1, DT1, L3, PP0, RL2, SH1, SR1, T6
IEEE-488.2 SCPI Syntax

RS232C Interface:

9 pin D-shell connector
Supplied with RS232C cable.

Constant Power AC Mode - Available Max. AC Current on MX45

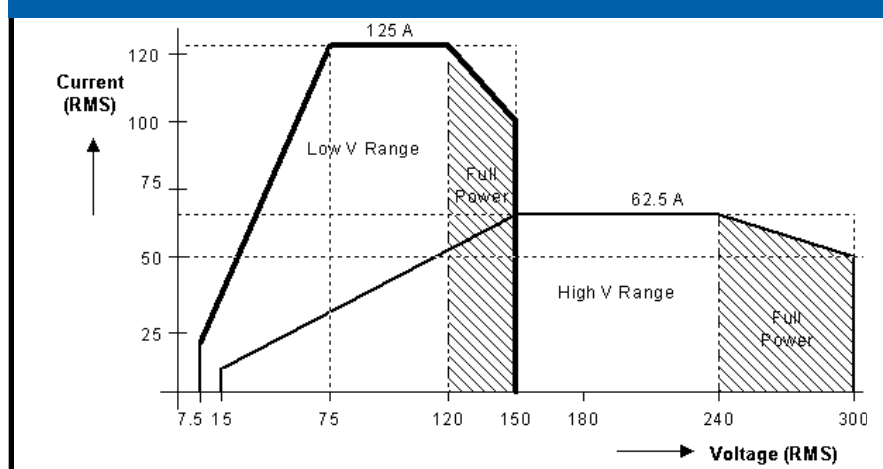

Specifications - Continued

System Interface

Inputs:

- Remote shutdown
- External Sync
- Clock/Lock (option on Pi)

Outputs:

- Function Strobe / Trigger out
- Clock/Lock (option on Pi)

AC Input

Voltage:

Must be specified at time of order. All inputs are L-L, 3 ϕ , 3 wire + Gnd.

- 208 \pm 10% V_{AC}
- 230 \pm 10% V_{AC}
- 400 \pm 10% V_{AC}
- 480 \pm 10% V_{AC}

Current (MX30):

Input Line Current (per phase)

V L-L	St State	Inrush
208	116 A _{RMS}	230 Apk
230	105 A _{RMS}	220 Apk
400	60 A _{RMS}	132 Apk
480	50 A _{RMS}	110 Apk

Distortion: < 8 % at full power
< 20 % below 35 % of power

Current (MX45):

Input Line Current (per phase)

V L-L	St State	Inrush
208	175 A _{RMS}	230 Apk
230	157 A _{RMS}	220 Apk
400	90 A _{RMS}	132 Apk
480	75 A _{RMS}	110 Apk

Distortion: < 8 % at full power
< 20 % below 35 % of power

Line Frequency: 47 - 63 Hz

Efficiency: 85 % typical

Power Factor: 0.95 typical

Hold-up Time: At least 10 ms

AC Service

Input: Front access, cables routed through rear panel, exit in back.

Output: Front access, cables routed through rear panel, exit in back.

Regulatory:

IEC61010, EN50081-2, EN50082-2, CE EMC and Safety Mark requirements

EMI:

CISPR 11, Group1 , Class A

Connectors

- AC Input terminal block behind front cover
- AC output terminal block behind front cover
- IEEE-488 (GPIB) connector, rear panel
- 9 pin D-Shell RS232C connector*, rear panel
- Remote voltage sense terminal block, rear panel
- System Interface Connector, DB-37, rear panel

(*RS232 DB9 to DB9 cable supplied)

Physical

Dimensions per MX30/MX45 unit

- Height : 50.0" (1270 mm)
- Width : 28.75" (731 mm)
- Depth : 34.5" (876 mm)

Weight

MX30/MX45 Chassis:

- Net: 1150 lbs / 522 Kg
- Shipping: 1231 lbs / 560 Kg

Amp Module:

- Net: 63 lbs / 29 Kg

Chassis:

Casters and forklift openings.

Vibration and Shock:

Designed to meet NSTA project 1A transportation levels. Units are shipped in wooden crate with forklift slots.

Air Intake/Exhaust:

Forced air cooling, front air intake, rear exhaust.

Operating Humidity:

0 to 95 % RAH, non condensing.

Temperature:

Operating: 0 to 40° C
(30° C max in CP mode)
Storage: -20 to +85° C

MX30/MX45 Dimensions - single chassis

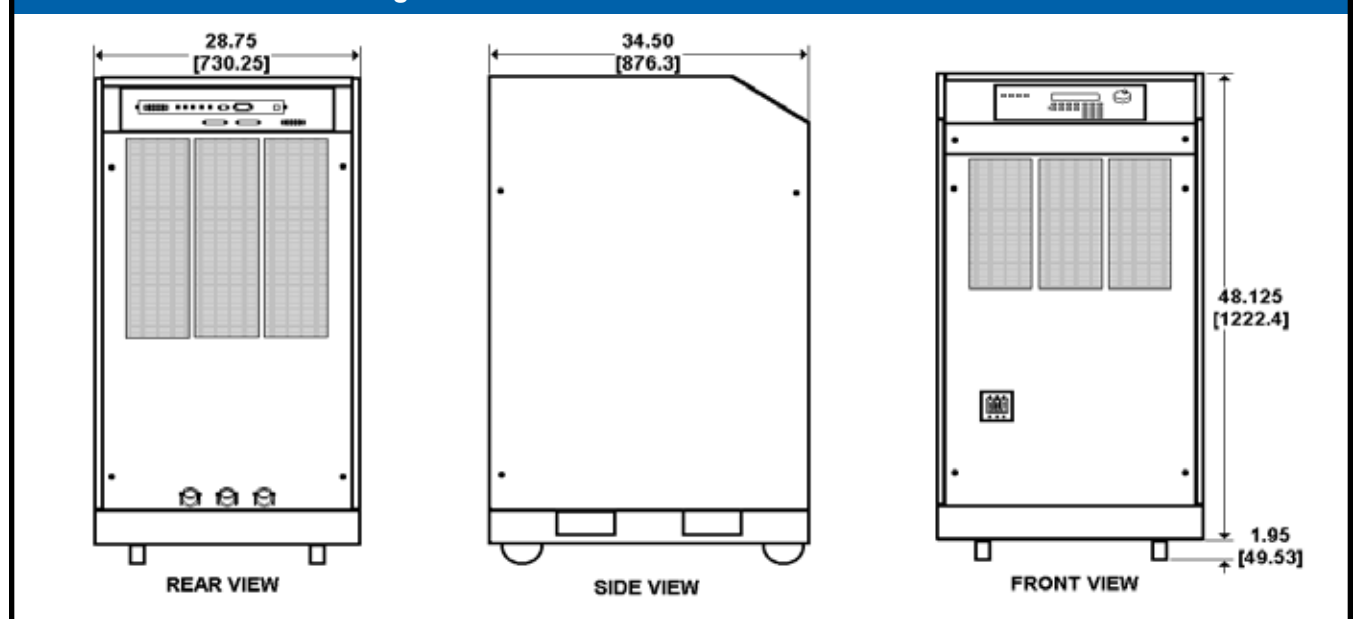

Ordering Information

Feature Comparison

Standard controller versions with single voltage range:

Model	AC Output Power	Phase Outputs	AC/DC Voltage Range	Controller
MX30-1	30 kVA	1	150/200 or 300/400	Standard
MX30-3	30 kVA	3	150/200 or 300/400	Standard
MX45-1	45 kVA	1	150/200 or 300/400	Standard
MX45-3	45 kVA	3	150/200 or 300/400	Standard
MX90-3	90 kVA	3	150/200 or 300/400	Standard
MX135-3	135 kVA	3	150/200 or 300/400	Standard

Programmable controller versions with dual voltage ranges:

Model	AC Output Power	Phase Outputs	AC/DC Voltage Ranges	Controller
MX30-3Pi	30 kVA	1 & 3	150/200 & 300/400	Programmable
MX45-3Pi	45 kVA	1 & 3	150/200 & 300/400	Programmable
MX90-3Pi	90 kVA	3	150/200 & 300/400	Programmable
MX135-3Pi	135 kVA	3	150/200 & 300/400	Programmable

Pi models include IEEE-488 and RS232C interfaces, Advanced measurements, arbitrary waveform generation. Phase mode switching on MX-30/45-3Pi.

Reconfigurable Power Systems:

Model	AC Output Power	Phase Outputs	AC/DC Voltage Ranges	Controller
MX90-3Pi-MB	90 kVA	3	150/200 & 300/400	Dual MX45-3Pi
MX135-3Pi-MB	135 kVA	3	150/200 & 300/400	Triple MX-45-3Pi

Reconfigurable systems can be separated into stand-alone MX45-3Pi models or combined for higher power levels.

Model

Refer to table shown for model numbers and configurations.

Supplied with

Standard: User Manual on CD ROM.
Pi version: User/Programming Manual and Software on CD ROM. RS232C serial cable.

Input Voltage Settings

Specify input voltage (L-L) setting for each MX system at time of order:

208 Configured for 208 V ±10 % L-L, 4 wire input.
230 Configured for 230 V ±10 % L-L, 4 wire input.
400 Configured for 400 V ±10 % L-L, 4 wire input.
480 Configured for 480 V ±10 % L-L, 4 wire input

Standard Model Options

Specify output range on standard models. All range values shown are Line to Neutral.

-150 Configured for 150 V AC and 200 V DC output ranges.
-300 Configured for 300 V AC and 400 V DC output ranges.
-LF Limits maximum frequency to 500 Hz.
-P IEEE-488 and RS232C Interface option. Adds programming, Windows software and RS232 Cable.
-R Range change. Provides both 150/200 and 300/400 AC/DC output ranges.

Pi Model Options

-160 RTCA/DO-160D and EU-ROCAE test firmware.
-411 IEC 1000-4-11 test firmware.

Controller:	Std	Pi
AC mode	x	x
DC mode	x	x
AC+DC mode		x
Dual V Range	Option	x
Transient programming	x	x
Arbitrary waveforms		x
Measurements	x	x
Harmonic measurements		x
Waveform acquisition		x
1 or 3 Phase mode		MX30/45-3Pi
IEEE / RS232	Option	x

Pi Model Options [Cont.]

-413 IEC 1000-4-13 Harmonics and Interharmonics test firmware.
-704 Mil Std 704 A - F test firmware/software.
-ABD ABD0100.1.8 Test Option.
-HV Adds 400 V AC-only output range.
-LF Limits maximum frequency to 500 Hz.
-XV Adds other AC-only output range. Consult factory.
-LKM Clock/Lock Master
-LKS Clock/Lock Auxiliary
-WHM Watt-Hour Measurement option.

Accessories

OMNI-3-75 Impedance matching network for IEC61000-3-11 flicker tests.

Packaging and Shipment

All MX systems are packaged in reusable protective wooden crates for shipment.

Contact California Instruments:

TEL: 858 677-9040

FAX: 858 677-0940

Email: sales@calinst.com

Web URL: http://www.calinst.com



9689 Towne Centre Drive, San Diego, CA 92121-1964

(858) 677-9040

FAX : (858) 677-0940

© Copyright 2005, California Instruments Corp.

Specifications subject to change without notice

Printed in the USA.

DSMX 02/06